

Single handle Tub&Shower faucet with Stop Value 128A Series

Feature:

- Metal lever handle
- Drip-free Ceramic cartridge
- With pressure balance valve
- 2.0 gallons per minute Max at 80 psi for shower head
- 2.5 gallons per minute Min at 20 psi for tub spout
- Solid brass waterway
- one function shower head

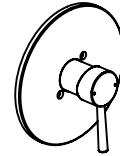
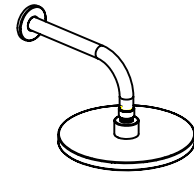

Codes/Standards Applicable:

Complies with:

- ANSI/ASME A112.18.1
- CSA B125-1
- IAPMO/UPC

Model No./Colors/Finishes:

- 128A-CP Polished Chrome
- 128A-BN Brush Nickel PVD
- 128A-NB Nobel Bronze
- 128A-ORB Oil Rubbed Bronze
- 128A-PB Polished Brass PVD

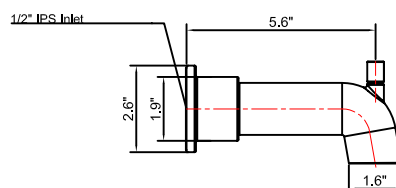
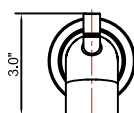
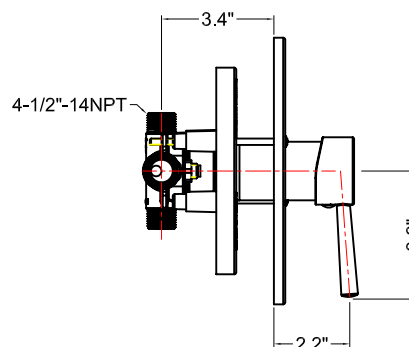
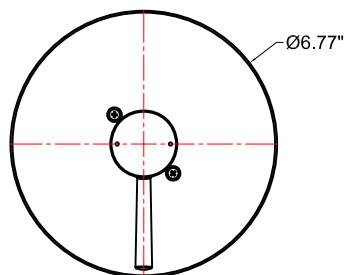
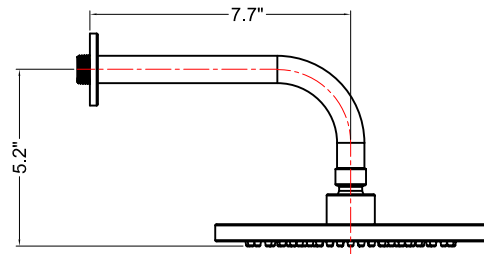
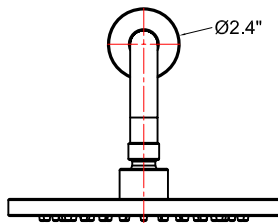

Product Diagram